

.100" (2.54mm) Mini-Match connector

HIDC254M1 Series Housings

- * Material : UL 94V-0
- * Standard color : Black
- * Contact : Phosphor bronze or Brass
- * Finish : Plated Tin or Plated Gold
- * Electrical rating : 3A, AC/DC
- * Dielectric withstanding : AC 500V
- * Mates with PIDC254M1I, PIDC254M1L
PIDC254M1I-BU, PIDC254M1L-BU
Series housings
- * 6-64 circuits available

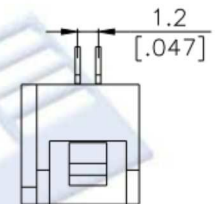
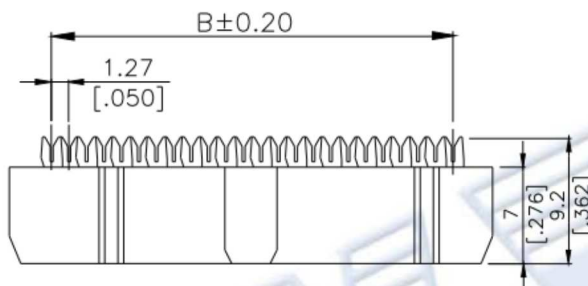
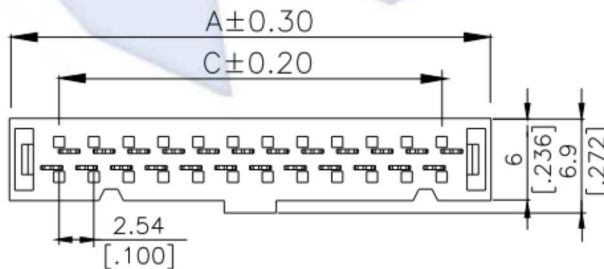
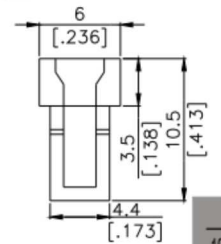
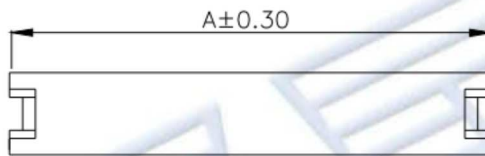
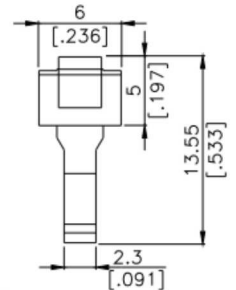
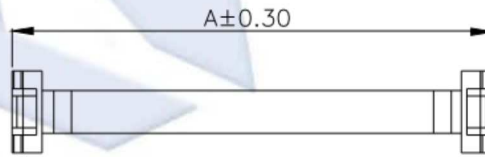
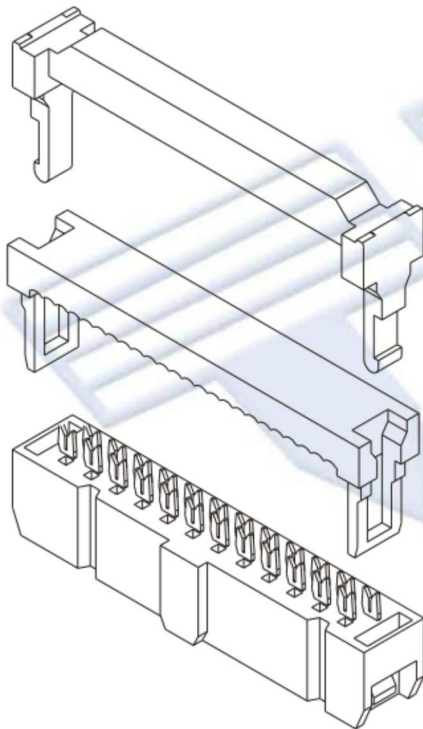
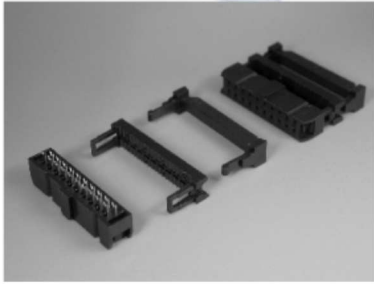

0
1.00"/2.54mm

Dimensional information - mm/inch (HIDC254M1)

Circuits	Dim. A		Dim. B		Dim. C		Circuits	Dim. A		Dim. B		Dim. C	
	inch	mm	inch	mm	inch	mm		inch	mm	inch	mm	inch	mm
6	0.485	12.32	0.250	6.35	0.200	5.08	26	1.485	37.72	1.250	31.75	1.200	30.48
8	0.585	14.86	0.350	8.89	0.300	7.62	30	1.685	42.80	1.450	36.83	1.400	35.56
10	0.685	17.40	0.450	11.43	0.400	10.16	34	1.885	47.88	1.650	41.91	1.600	40.64
12	0.785	19.94	0.550	13.97	0.500	12.70	36	1.985	50.42	1.750	44.45	1.700	43.18
14	0.885	22.48	0.650	16.51	0.600	15.24	40	2.185	55.50	1.950	49.53	1.900	48.26
16	0.985	25.02	0.750	19.05	0.700	17.78	44	2.385	60.58	2.150	54.61	2.100	53.34
18	1.085	27.56	0.850	21.59	0.800	20.32	50	2.685	68.20	2.450	62.23	2.400	60.96
20	1.185	30.10	0.950	24.13	0.900	22.86	60	3.185	80.90	2.950	74.93	2.900	73.66
24	1.385	35.18	1.150	29.21	1.100	27.94	64	3.385	85.98	3.150	80.01	3.100	78.74