

# SK 70 WT

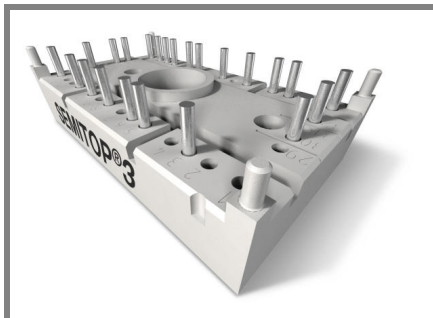

SEMITOP<sup>®</sup> 3

## Antiparallel Thyristor Module

### SK 70 WT

Preliminary Data

#### Features

- Compact Design
- One screw mounting
- Heat transfer and isolation through direct copper bonded aluminium oxide ceramic (DCB)
- Glass passivated thyristor chips
- Up to 1600V reverse voltage
- UL recognized, file no. E 63 532

#### Typical Applications\*

- Soft starters
- Light control (studios, theaters...)
- Temperature control

$V_{RSM}$ V	$V_{RRM}, V_{DRM}$ V	$I_{RMS} = 72 \text{ A (full conduction)}$ ( $T_s = 85 \text{ °C}$ )
900	800	SK 70 WT 08
1300	1200	SK 70 WT 12
1700	1600	SK 70 WT 16

Symbol	Conditions	Values	Units
$I_{RMS}$	W1C ; sin. 180° ; $T_s = 100 \text{ °C}$	50	A
	W1C ; sin. 180° ; $T_s = 85 \text{ °C}$	72	A
$I_{TSM}$	$T_{vj} = 25 \text{ °C}$ ; 10 ms	1000	A
	$T_{vj} = 125 \text{ °C}$ ; 10 ms	900	A
$i^2t$	$T_{vj} = 25 \text{ °C}$ ; 8,3 ... 10 ms	5000	A <sup>2</sup> s
	$T_{vj} = 125 \text{ °C}$ ; 8,3 ... 10 ms	4000	A <sup>2</sup> s
$V_T$	$T_{vj} = 25 \text{ °C}$ , $I_T = 120 \text{ A}$	max. 1,8	V
$V_{T(TO)}$	$T_{vj} = 125 \text{ °C}$	max. 1	V
$r_T$	$T_{vj} = 125 \text{ °C}$	max. 6	mΩ
$I_{DD}, I_{RD}$	$T_{vj} = 25 \text{ °C}$ , $V_{RD} = V_{RRM}$	max. 0,5	mA
	$T_{vj} = 125 \text{ °C}$ , $V_{RD} = V_{RRM}$	max. 15	mA
$t_{gd}$	$T_{vj} = 25 \text{ °C}$ , $I_G = 1 \text{ A}$ ; $di_G/dt = 1 \text{ A}/\mu\text{s}$	1	μs
$t_{gr}$	$V_D = 0,67 * V_{DRM}$	2	μs
$(dv/dt)_{cr}$	$T_{vj} = 125 \text{ °C}$	1000	V/μs
$(di/dt)_{cr}$	$T_{vj} = 125 \text{ °C}$ ; $f = 50 \dots 60 \text{ Hz}$	50	A/μs
$t_q$	$T_{vj} = 125 \text{ °C}$ ; typ.	80	μs
$I_H$	$T_{vj} = 25 \text{ °C}$ ; typ. / max.	100 / 200	mA
$I_L$	$T_{vj} = 25 \text{ °C}$ ; $R_G = 33 \text{ Ω}$ ; typ. / max.	200 / 400	mA
$V_{GT}$	$T_{vj} = 25 \text{ °C}$ ; d.c.	min. 2	V
$I_{GT}$	$T_{vj} = 25 \text{ °C}$ ; d.c.	min. 100	mA
$V_{GD}$	$T_{vj} = 125 \text{ °C}$ ; d.c.	max. 0,25	V
$I_{GD}$	$T_{vj} = 125 \text{ °C}$ ; d.c.	max. 5	mA
$R_{th(j-s)}$	cont. per thyristor	0,8	K/W
	sin 180° per thyristor	0,84	K/W
$R_{th(j-s)}$	cont. per W1C	0,4	K/W
	sin 180° per W1C	0,42	K/W
$T_{vj}$		-40 ... +125	°C
$T_{stg}$		-40 ... +125	°C
$T_{solder}$	terminals, 10 s	260	°C
$V_{isol}$	a. c. 50 Hz; r.m.s.; 1 s / 1 min.	3000 / 2500	V~
$M_s$		2,5	Nm
$M_t$			Nm
$a$			m/s <sup>2</sup>
$m$		30	g
Case	SEMITOP <sup>®</sup> 3	T 63	

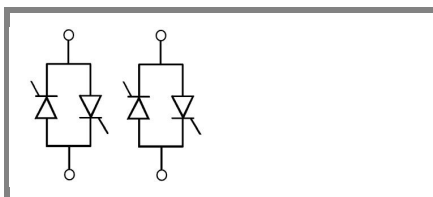

WT

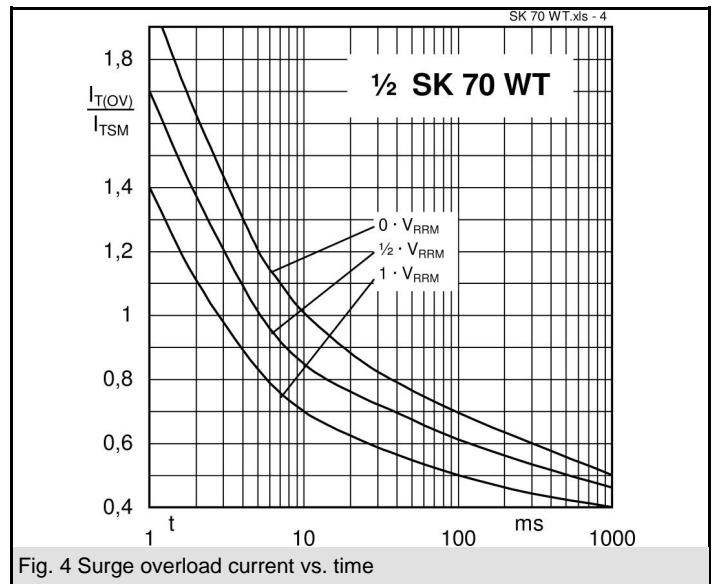
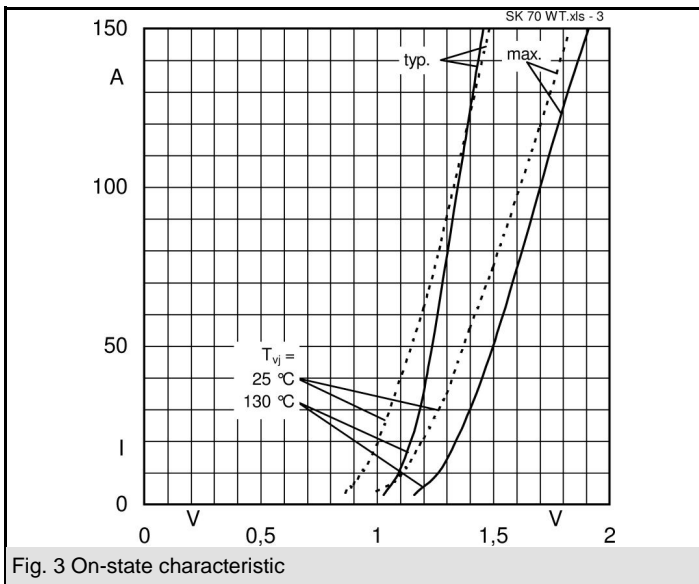
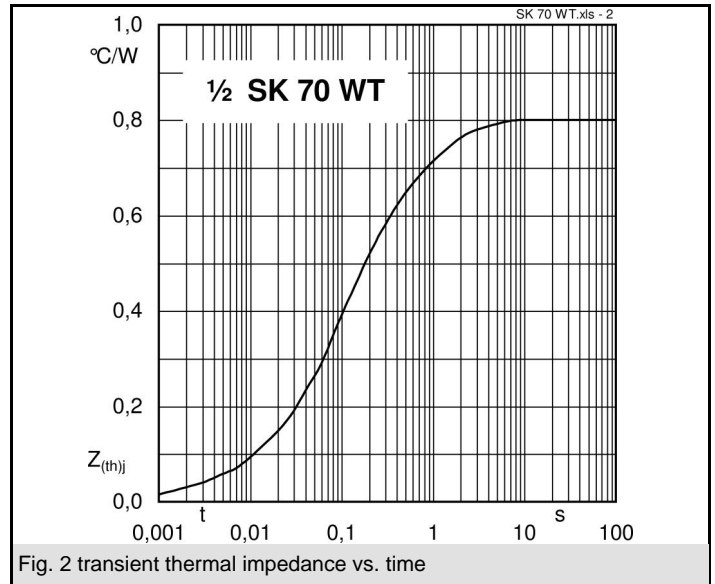
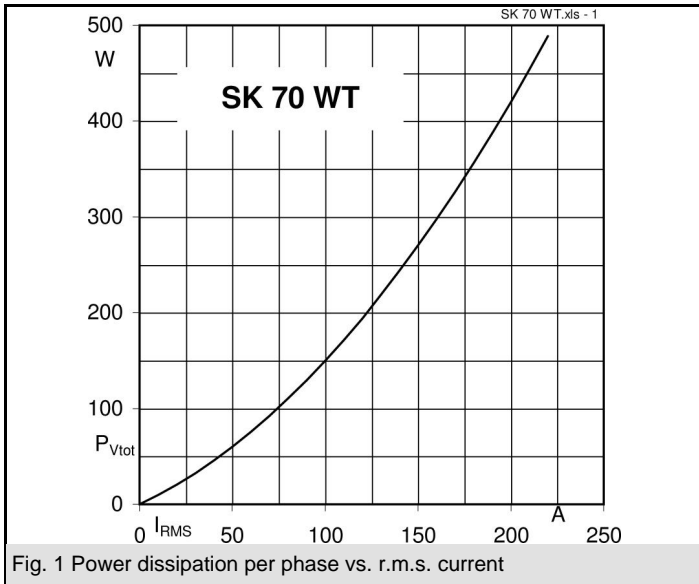

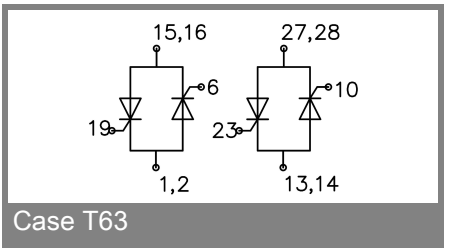
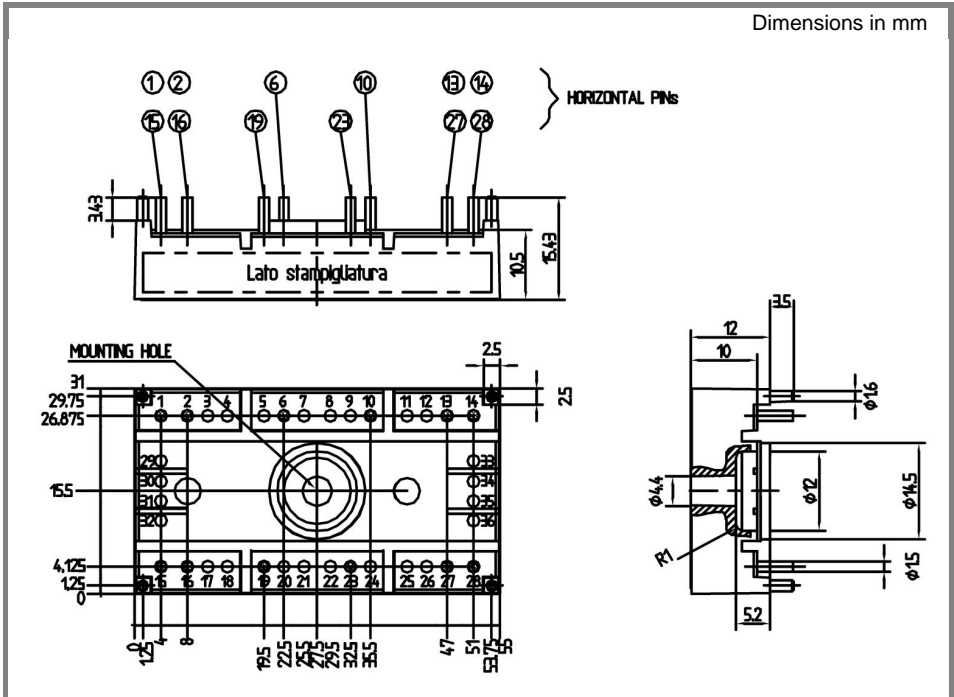
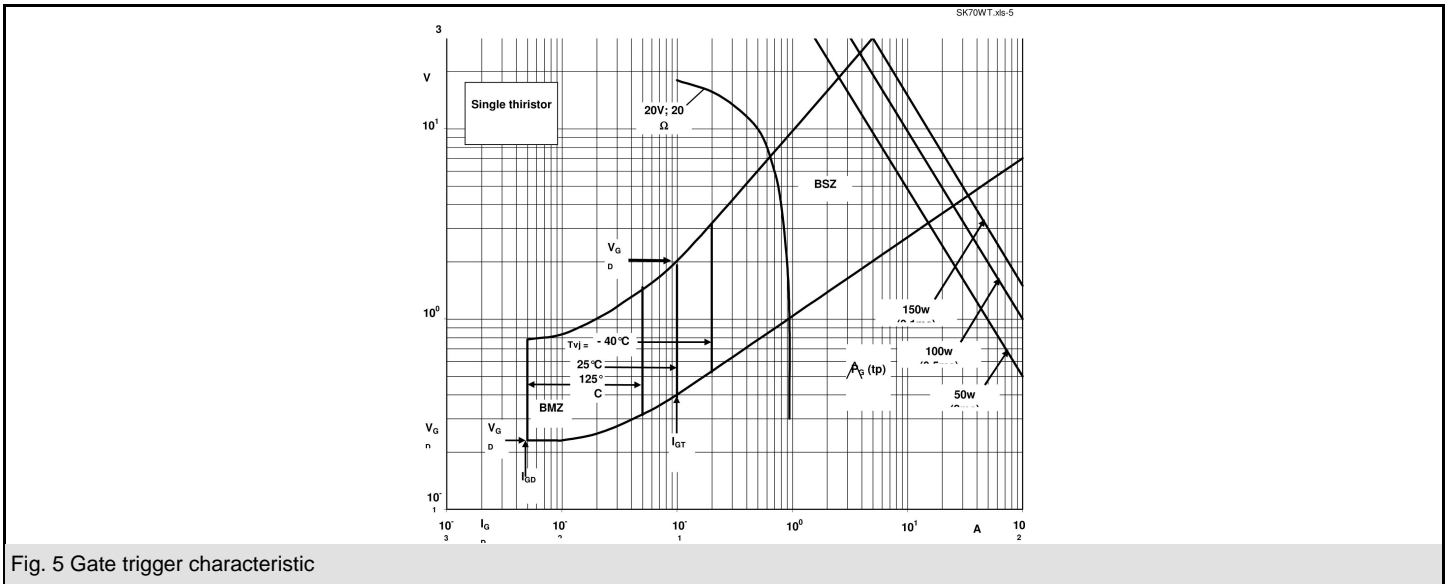

Case T63 (Suggested hole diameter in the PCB for solder pins and mounting pins: 2mm)

\* The specifications of our components may not be considered as an assurance of component characteristics. Components have to be tested for the respective application. Adjustments may be necessary. The use of SEMIKRON products in life support appliances and systems is subject to prior specification and written approval by SEMIKRON. We therefore strongly recommend prior consultation of our personal.