

ROHS Compliant



台灣駿品端子股份有限公司
TAIWAN KING PIN TERMINAL CO.,LTD

台北縣樹林市俊德街 23 號

TEL:886-2-26895596.26886112 FAX:886-2-26886110
E-mail:info@tkp.com.tw http://www.tkp.com.tw

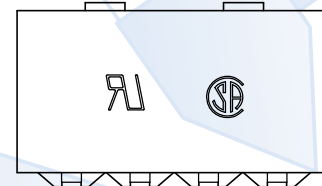
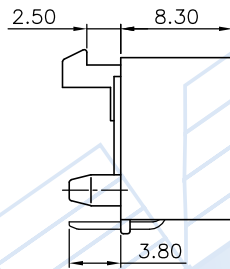
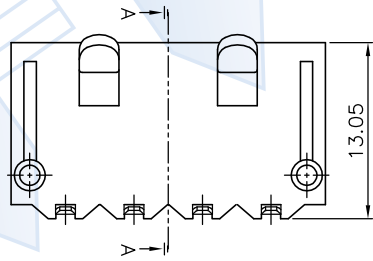
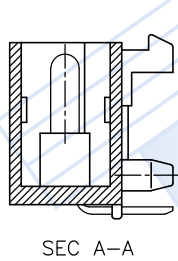
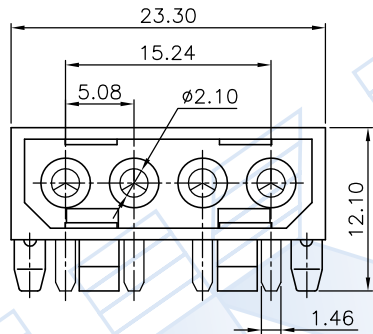

- NOTE :
- * Material : Nylon UL 94V-2(Lead Free)
 - * Contact : Brass
 - * Electrical rating : UL 30V 8.3A, AC/DC
CSA 250V 4.5A, AC/DC
 - * Finish : Tin-plated
 - * Split pins
 - * Mates with 870156 IDT, 4070
or 5050-04 connectors
 - * 4 Circuits

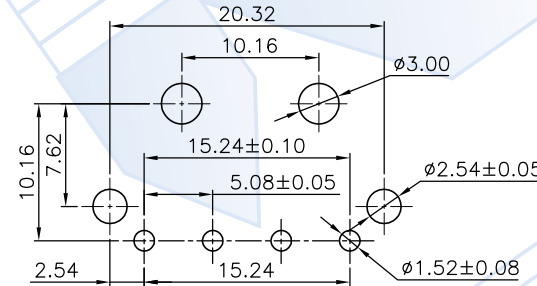
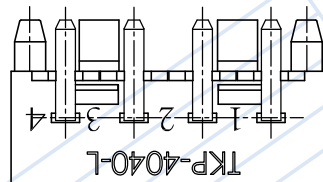

RECOMMENDED PCB LAYOUT

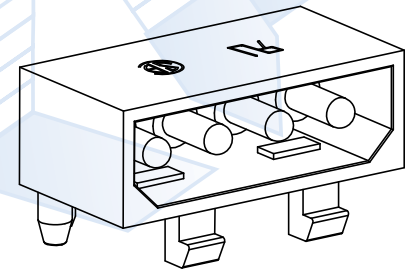

PART NO.	4040L-04			Part NO.	Material	Color/Finish	Remark	APPROVAL
TITLE	5.08mm Wire to Board							DRAWN: 唐雅茹
THIRD ANGLE	SCALE	UNIT	SHEET NO	TOLERANCE	DATE	ODD NUMBERS	REV	CHECKED: 唐雅茹
	1.5:1	mm	1/1	.X± 0.30 .XXX±0.10 .XX± 0.20 ANGLE±2°	2010.01.28	ENG950495	A2	APPROVED: 陳泓宇
	508-005		A508-001					