

# Fan filter guard grilles

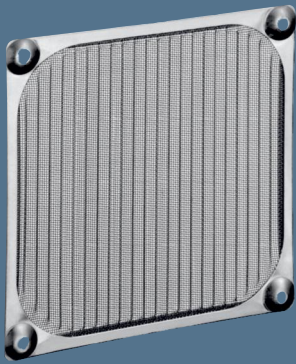

- Filter guard grilles consist of a mounting plate, filter and screen.
- Screen LZ40 N made of black, fibreglass-reinforced plastic with inserted wire netting LZ60.
- Filter LZ60 made of Nirosta stainless steel wire netting.
- Mounting plate LZ40-1 for installation.

## Fan series DC

4400 F  
4400 FN  
4300  
4300 N  
4400  
4200  
4100 N

## Fan series AC

AC 4300  
9900  
4000 N  
4000 Z

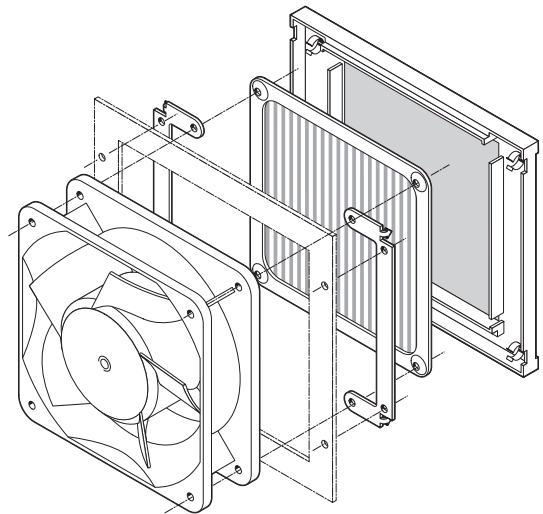

LZ40N

Screen

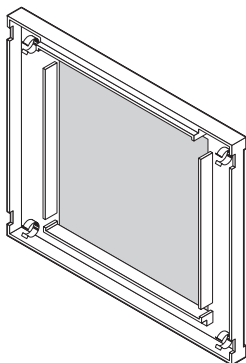

LZ40-1

Bracket

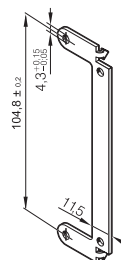
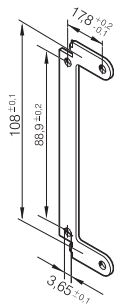

LZ60

Filter

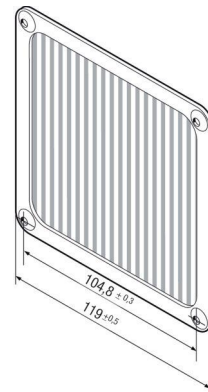

# Fan filter guard grilles

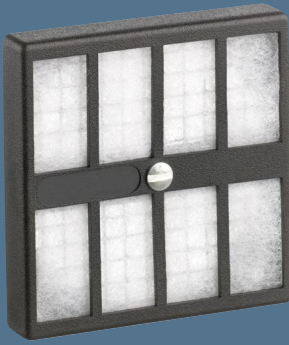

- Filter guard grille suitable for attachment to axial fan series of size 60 mm, 80 mm, 92 mm, 119 mm,  $\varnothing$  172 mm. All filter units fit directly onto the existing installation holes of the fans.
- Filter guard grille consisting of 3 parts: outer grille barrier, inner fastening plate and replaceable filter mat.
- Grille barrier made of moulded polycarbonate (PC), with matted surface.
- Fast and easy exchange of filter mat by a quick release on the grille barrier.
- Fastening plate made of wire netting, with black powder coating.
- Filter mat can be replaced while the fan is running, protection provided by welded wire netting.
- Filter mat made of white, synthetically bonded fibres.

Protection filter	Fan size	A	B	C	D	Replacement filter*
FF60	60 x 60 mm	65	65	13,5	50,0	RF 60
FF80	80 x 80 mm	85	85	14,0	71,5	RF 80
FF92	92 x 92 mm	125	105	17,5	82,5	RF 92
FF119	119 x 119 mm	162	136	18,5	104,5	RF 119
FF172	$\varnothing$ 172 mm	226	190	19,5	162,0	RF 172

\* Replacement filters only in packs of 5.

## FF60 / FF80

Fan size: 60 x 60 mm  
80 x 80 mm

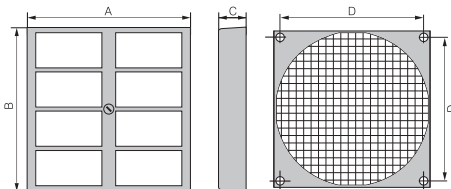

## FF92 / FF 119

Fan size: 92 x 92 mm  
119 x 119 mm

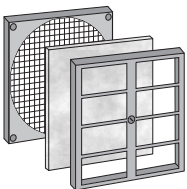
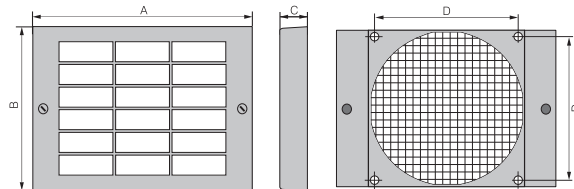

## FF 172

Fan size:  $\varnothing$  172 mm

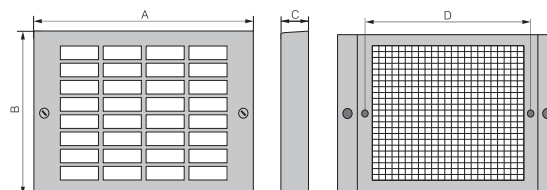

### Filter capacity

A fan filter guard filters out up to 75% of dust particles up to a size of 5-10 microns and withstands temperatures of up to 100°C. Flame retardant in accordance with DIN 53438, grade F1. For installed, clean filters, an air flow reduction of 20 – 30% can be assumed.